

985920 | Matrices de engatillar hexagonales

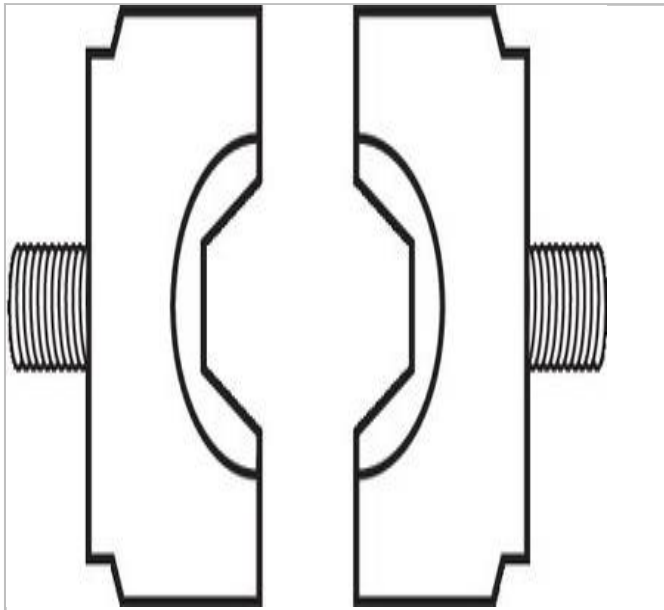

Description:

- Para alicates de engatillar 985913.
- Para terminales y manguitos tubulares.



	985920
Peso [g]	78.0