

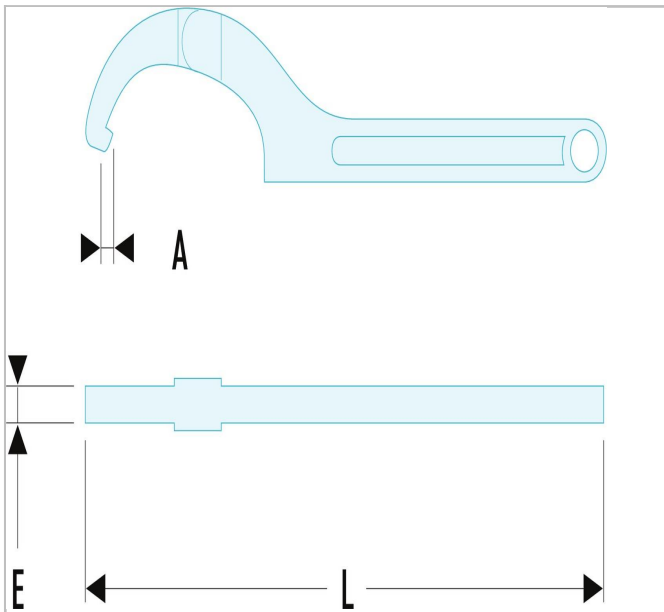

## 125A.120 | 125A - Hinged models



### Description:

- The hinge is fitted with a spring washer guaranteeing smooth and reliable operation.
- These 5 dimensions replace more wrenches than classical fixed models.
- Capacity: 15 to 180 mm.
- Presentation: satin chrome finish.



	<b>125A.120</b>
A [mm]	5.5
A [in]	
Diameter [mm]	80 - 120
Thickness E [mm]	9.0
Length [mm]	345.0
Weight [Kg]	0.7