

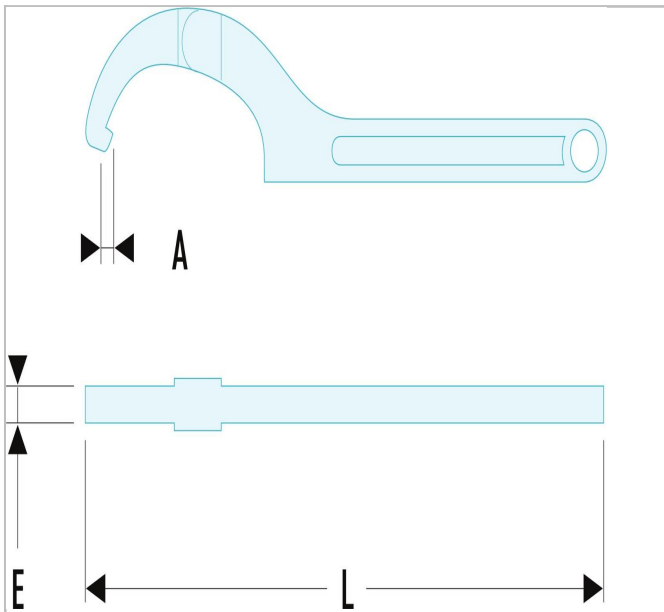

125A.35 | 125A - Hinged models



Description:

- The hinge is fitted with a spring washer guaranteeing smooth and reliable operation.
- These 5 dimensions replace more wrenches than classical fixed models.
- Capacity: 15 to 180 mm.
- Presentation: satin chrome finish.



	125A.35
A [mm]	3.0
A [in]	
Diameter [mm]	15 - 35
Thickness E [mm]	5.0
Length [mm]	168.0
Weight [Kg]	0.08